

MAHR SPOTLIGHTS



KOMPETENZPREIS
BADEN-WÜRTTEMBERG

Recognized for
excellent achievements
in innovation and
quality



END OF YEAR PROMOTION
PROMOTION PRICES VALID UNTIL
12/31/2011

|
- 0 +



EXACTLY



Extended because
of demand

MarCal. The new Generation with the Reference-System

WATERPROOF CALIPERS

Superior quality of the guideways

Only MarCal calipers have lapped guide way surfaces, these guarantee an even and sensitive run of the slide. Additionally, the service life of the caliper increases compared to a ground guide way due to the greater contact area on the guideway surface.



Surface of the guide way

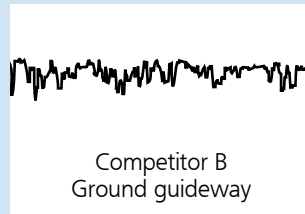
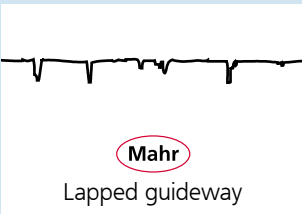

50% longer battery lifetime

The new Reference system is extremely energy efficient as when the caliper is in standby mode; almost no power is required, thus extending the life of the battery to up to 50%.

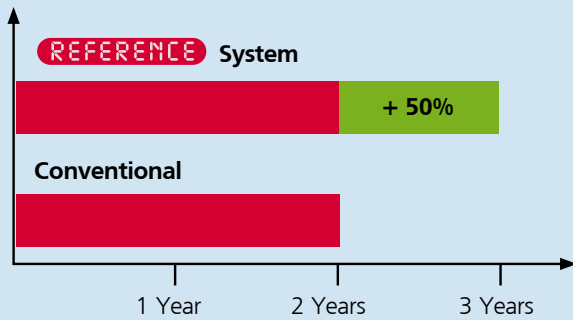

Security due to the Reference-Lock function

- Zero-position is secured
- Operating error is not possible

The Digital Caliper MarCal 16 EWR Reference is equipped with a LOCK function. With this key lock, the zero position is secured and operating error is avoided.



MarCal - The innovative Reference-System

Just set once to zero

All Mahr digital calipers with this logo **REFERENCE** are equipped with zero position just has to be set once: after setting the zero position, the zero remains. Therefore, once the caliper is switched ON or the slide is moved, the caliper is in zero position. No need to reset to zero with a conventional caliper once the caliper is switched ON.

REFERENCE System

- ① Switch ON

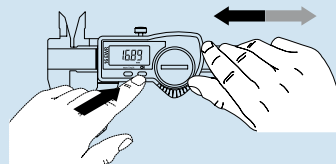

The only one with a universal MarConnect interface

Regardless of which evaluation device you are using, with a MarConnect interface you always have the optimal connection.



USB ready: For direct connection to a PC when using our MarCom software you can transfer your measured values directly into MS Excel or with a keyboard code into any application.



Digimatic: To connect to Digimatic compatible evaluation devices.



Mahr Opto RS232C: To connect to the COM interface on a PC.

Ergonomic Design

The handy non-slip thumb support of the MarCal 16 EWR ensures even in contaminated working conditions trouble-free handling and therefore reliable measuring results.



The high-contrast display with 8.5 mm high digits enables accurate, fatigue-free reading of the measurement results.

Excellent resistance against dust, coolant and lubricants



Due to the outstanding protection against dust and water, the Digital Caliper MarCal 16 EWR Reference delivers precise and secure results even in the most difficult workshop conditions.



h the innovative Reference-System. The
nains stored for all further measurements.
mmediately ready for measurement. The
on has now become obsolete.

② Result of measurement

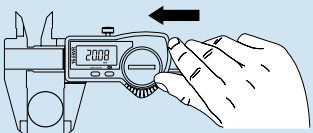

Code Initials	IP	International Protection
First digit	6	Dust-tight
Second digit	7	Protected against temporary immersion in water

How to Receive Your Free Caliper

▶ | This end of year promotion brochure is loaded with many products carrying a **Free Caliper Symbol** as seen here. When you order a product with the Free Caliper Symbol from this brochure - by the special order number specified, you will also receive one free **16 ER** - our newest and performance packed caliper, order number **4103000**.

The values in this brochure are hot, but when combined with the free 16 ER they are untouchable!

Order yours today. | ◀



ree
16 ER Caliper

List Price: \$129.00



REFERENCE

NEW

Price
\$149.00
Order no. 4103060

Functions:

- ON/OFF, RESET (Set display to zero), mm/inch, Reference-Lock/Unlock, Auto-ON/OFF
- Immediate measurement due to the **Reference system**
- Excellent resistance against dust, coolants and lubricants, **Protection Class IP67**
- Life of the battery up to **3 years**
- High contrast Liquid Crystal Display with 8.5 mm high digits
- Lapped guideway



For further detailed information see:
www.mahr.com
WebCode 13526-11250

	Measuring range	Resolution	Depth rod		Friction Wheel	Order no.	Price
	mm (inch)	mm / inch					
16 EWR	150 (6")	0.01 / .0005"	●			4103060	\$149.00
16 EWR	150 (6")	0.01 / .0005"		●		4103062	\$149.00
16 EWR	150 (6")	0.01 / .0005"	●		●	4103061	\$149.00
16 EWR	150 (6")	0.01 / .0005"		●	●	4103063	\$149.00

MarCal. Digital Caliper 16 EWR with Reference System, Protection Class IP67



Price from
\$190.00



Functions:

- ON/OFF, RESET (Set display to zero), mm/inch, Reference-Lock/Unlock, DATA (Data transmission via connection cable), Auto-ON/OFF
- Immediate measurement due to the **Reference system**
- Excellent resistance against dust, coolants and lubricants, **protection class IP67**
- **MarConnect** data output, choose alternatively: USB, OPTO RS232C or Digimatic
- Life of the battery up to **3 years**
- High contrast Liquid Crystal Display with 8.5 mm high digits
- Measuring blades for inside measurement

For further detailed information see:
www.mahr.com
WebCode 2553

	Measuring Range		Resolution	Depth Rod			Friction Wheel	Order no.	Price
	mm	(inch)		mm / inch					
16 EWR	150	(6")	0.01 / .0005"	•				4103064	\$190.00
16 EWR	150	(6")	0.01 / .0005"		•			4103066	\$190.00
16 EWR	150	(6")	0.01 / .0005"	•		•		4103065	\$190.00
16 EWR	200	(8")	0.01 / .0005"		•	•		4103069	\$230.00
16 EWR	300	(12")	0.01 / .0005"			•		4103071	\$350.00

* With measuring blades for outside measurement

MarCal. Digital Caliper 16 ER with Reference System



Price
\$99.00

Functions:

- ON/OFF, RESET (Set display to zero), mm/inch, Reference-Lock/Unlock, Auto-ON/OFF
- Immediate measurement due to the **Reference system**
- Life of the battery up to **3 years**
- High contrast Liquid Crystal Display with 8.5 mm high digits
- Measuring blades for inside measurement

For further detailed information see:
www.mahr.com
WebCode 13522-11245

	Measuring range		Resolution	Depth Rod		Order no.	Price
	mm	(inch)		mm / inch			
16 ER	150	(6")	0.01 / .0005"	•		4103000	\$99.00
16 ER	150	(6")	0.01 / .0005"		•	4103001	\$99.00

MarCal. Digital Caliper 16 ER with Reference system

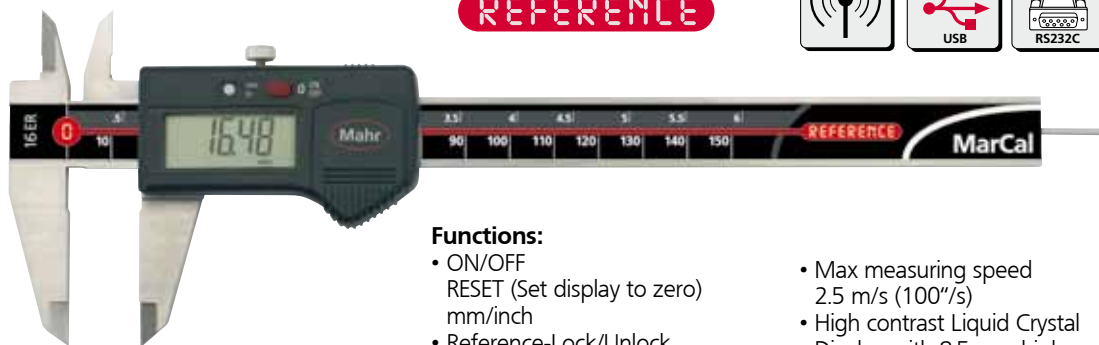

REFERENCE

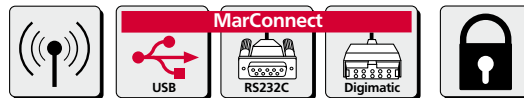

Price from
\$129.00



Functions:

- ON/OFF RESET (Set display to zero) mm/inch
- Reference-Lock/Unlock Auto-ON/OFF
- Immediate measurement due to the Reference system
- Dirt wipers are integrated in the slide
- Life of the battery up to 3 years
- Max measuring speed 2.5 m/s (100"/s)
- High contrast Liquid Crystal Display with 8.5 mm high digits
- Lapped guideway
- Slide and beam made of hardened stainless steel
- Measuring blades for inside measurement
- Step measuring function
- Locking screw
- Supplied with: Case, battery, operating instructions



For further detailed information see:

www.mahr.com
WebCode 2184

	Measuring range		Resolution		Depth Rod		Order no.	Price
	mm	(inch)	mm	inch				
16 ER	150	(6")	0,01	0.0005"	•	•	4103002	\$129.00
16 ER	150	(6")	0,01	0.0005"	•	•	4103003	\$129.00
16 ER	200	(8")	0,01	0.0005"	•	•	4103004	\$175.00
16 ER	300	(12")	0,01	0.0005"	•	•	4103005	\$275.00

Micromar. Digital Micrometer 40 EWR



REFERENCE



Functions:

- RESET (Zero setting the display for Relative measurement), ABS (Switching from Relative to Absolute measurement), mm/inch, PRESET (enter a numerical value) RESET (Reference setting)
- Waterproof measuring system **IP65**
- Reference measuring system, life of battery approx. 3 years
- High contrast Liquid Crystal Display with 8.5 mm high digits
- Measuring spindle and anvil are carbide tipped
- Operating buttons are made from **Ultradur®**, which has an excellent chemical resistance
- Immediate measurement due to the Reference System



Price
\$250.00



For further detailed information see:

www.mahr.com
WebCode 9331

	Measuring range		Resolution	Order no.	Price
	mm	(inch)	mm / inch		
40 EWR	0 - 25	(0 - 1")	0.001 / .00005"	4151721	\$250.00

MarTest. Test Indicators 801

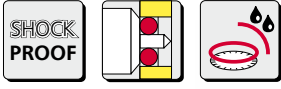

- Sealed, water proof dial face
- Anti magnetic
- Movement bearings are jewelled



801 S

Price
\$149.00
Order no. 4305950

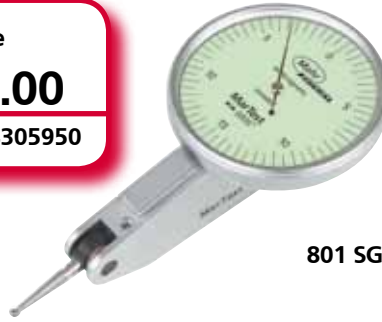

801 SG

Price
\$168.00
Order no. 4307950



801 SGM

Offer price
\$189.00
Order no. 4308970



801 SL

Offer price
\$183.00
Order no. 4306950

Design features of MarTest Test Indicators



Mechanism

- Shockproof
- Anti magnetic
- Movement bearings are jewelled with 8 precious stones
- Automatic matching to sensing direction, thus ensuring error-free reading

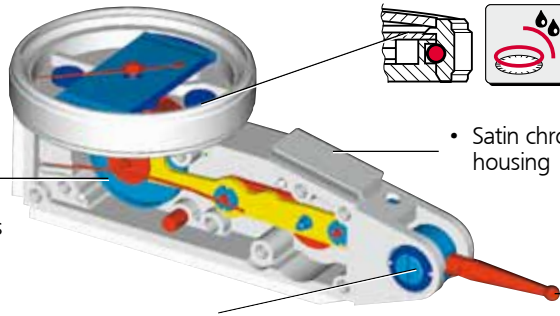
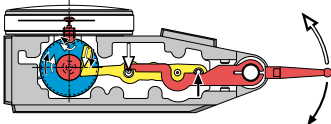

- Dial face is sealed with an O-Ring
- Satin chrome finished housing
- Contact point with carbide ball
- Double lever supported in ball bearings, overload protection provided by slip clutch



For further detailed information see:
www.mahr.com
WebCode 10863

	Measuring range	Readings	Dial dia.	Length of styli	Order no.	Price
	inch	inch	inch	inch		
801 S	.030"	.0005"	1.10"	.500"	4305950	\$149.00
801 SG	.030"	.0005"	1.500"	.500"	4307950	\$168.00
801 SL	.020"	.0005"	1.10"	1.4375"	4306950	\$183.00
801 SGM	.008"	.0001"	1.500"	.500"	4308970	\$189.00

μMaxμm® II Digital Comparator

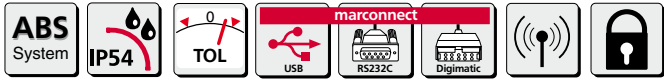

Starting at
\$345.00



NEW

Features - μMaxμm II and μMaxμm II XL

Functions:

- Inch/Metric – operator selectable with switchable resolution.
- Normal / Reverse Sensing
- Preset capabilities to view actual size.
- “Absolute” Transducer – no overspeed errors or constant re-zeroing. Transducer always remembers its location, even if power is off.
- High resolution digital readout and analog bar graph – digital display shows deviation from zero or actual dimension size (Preset).
- Lightweight, contamination resistant – ruggedly built to withstand hard use – gasketed case, crystal and stem assemblies resist fluid contamination.
- Calibratable – if ever needed – values remembered even after battery change.
- Marconnect data output: USB, OPTO RS232C, Digimatic
- Auto-power down – provides extremely low battery consumption, assuring long life from readily available commercial batteries.
- Increased resolution (0.0002mm / 10uinch) for today's demanding tolerances.
- Unilateral Tolerances
- Go/NoGo Display Feature

Ordering Information - μMaxμm II

Model	Range mm / inch	Resolution mm / inch	Accuracy % of digital range	Stem diameter	Stem Length	Order no.	Price
Standard	±1.00 / ±0.040"	Selectable:	±0.25% over ±0.50mm / ±0.020" ±0.50% from to ±1.00mm / ±0.040"	0.375"	11.7mm / 0.46"	2034101	\$345.00
Standard		0.0002 / 0.00001"		0.375"	38.0mm / 1.50"	2034103	\$345.00
Standard		0.0005 / 0.00002"		8mm	11.7mm / 0.46"	2034105	\$345.00
Standard		0.001 / 0.00005"		8mm	38.0mm / 1.50"	2034107	\$345.00
Advanced	±1.00 / ±0.040"	0.002 / 0.00001"	±0.50mm / ±0.020" to ±1.00mm / ±0.040"	0.375"	11.7mm / 0.46"	2034201	\$432.00
Advanced		0.005 / 0.0002"		0.375"	38.0mm / 1.50"	2034203	\$432.00
Advanced		0.01 / 0.0005"		8mm	11.7mm / 0.46"	2034205	\$432.00
Advanced		0.02 / 0.001"		8mm	38.0mm / 1.50"	2034207	\$432.00
Advanced Perpendicular				0.375	11.7mm / 0.46"	2034401	\$432.00

Accessories - μMaxμm II

	Order No.		Order No.
Backs:		Other Hardware:	
Flat Black (Standard on all models)	EBK-1018	Splash Cover	ECV-1307-W2
Lug Back (Horizontal / Vertical)	EBK-1010	Adaptor Bushing (8mm to 3/8")	BU-197
Post Back (0.5" dia. x 1" long)	EBK-1012	Thread Adaptor (M2.5 to 4-48 thread)	AD-185
Screw Back (11/16" dia x 0.5", 1/4-28 thread)	EBK-1013	Spring (for lighter gaging force: 35g)	SP-351
Adj. Slide Back (0.5" slot, 1/4-20 thread)	EBK-1016		
Adj. Rack Back*	EBK-1014		
*used on AT-28 or AT-116 - Sold seperately.			
Data Interface:			
USB Cable (for MarCom or PC, 2m length)	4346023		
RS232 Cable (10pin plug, 2m length)	4346020		
Digimatic Cable (10pin plug, 2m length)	4346021		
Transmitter (Mahr t, used w/ FM1 Receiver)	2121369		

Made in USA
Available for fast delivery

μMaxμm® II XL Digital Indicator

Features - μMaxμm II and μMaxμm II XL

Advanced Functions:

- Dynamic mode operation:
 - Max, Min, TIR
- Two point difference measurement – provides comparison of two readings or measuring locations.
 - ☰ - Calculate the distance between 2 measured values
- Multiplier factor for ratio measurements
- Hold function – holds reading on display until ready to resume measuring
- Data output with serial number identification capability 
- Data output with selectable continuous output or single request of reading(s)

Optional Factory Configured Features:

- Locked Multiplier factor for ratio measurements
- Disabled sleep mode (manual ON/OFF)
- Locked inch or mm display unit
- Power up in inch or mm unit on battery change
- Setup mode lockout with password entry



Starting at
\$432.00



Ordering Information - μMaxμm® II XL

Model	Range	Resolution mm / inch	Accuracy mm / inch	Stem diameter	Stem Length	Order no.	Price
US Version	0.5"	Selectable: Low: 0.1 / 0.005"	0.005 / 0.0002"	0.375"	16mm / 0.63"	2034252	\$432.00
US Version	1.0"			0.375"	16mm / 0.63"	2034212	\$498.00
World Version	12.5mm	High: 0.0002 / 0.00001"	0.0002 / 0.00001"	8mm	16mm / 0.63"	2034258	\$432.00
World Version	25mm			8mm	16mm / 0.63"	2034218	\$498.00
World Version*	25mm			8mm	16mm / 0.63"	2034210	\$498.00
World Version	50mm			8mm	16mm / 0.63"	2034229	\$648.00
World Version	100mm	High: 0.0002/0.00001"	0.009 / 0.00036"	8mm	16mm / 0.63"	2034249	\$798.00

Accessories - μMaxμm® II XL

	Order No.		Order No.
Backs:		Other Hardware:	
Flat Back (Standard on all models)	EBK-1020	Splash Cover	ECV-1307-W2
Lug Back (Horizontal / Vertical) .5" & 1" models	BK-183	Adaptor Bushing (8mm to 3/8")	BU-197
Lug Back (Horizontal / Vertical) 2" & 4" models	BK-383	Thread Adaptor (M2.5 to 4-48 thread)	AD-185
Post Back (0.5" dia. x 1" long)	BK-2093	Lifting lever (.05" tp 1.0" models):	
Screw Back (11/16" dia x 0.5", 1/4-28 thread)	BK-692	• Right hand style	ELR-1092
Adj. Slide Back (0.5" slot, 1/4-20 thread)	BK-531	• Left hand style (offset use only)	ELR-1093
Adj. Rack Back*	BK-93	• Ox-bow style	LR-40
<i>*used on AT-28 or AT-116 - Sold separately.</i>		Adaptor Back	EPL-1914
Data Interface:			
USB Cable (for MarCom or PC, 2m length)	4346023		
RS232 Cable (Opto-RS232C, 2m length)	4346020		
Digimatic Cable (10pin plug, 2m length)	4346021		
Transmitter (Mahr t, used w/ FM1 Receiver)	2121369		

Made in USA
Available for fast delivery

Digimar. Height Measuring and Scribing Instrument 814 SR



REFERENCE

- Functions:
RESET (Zero setting the display for Relative measurement),
ABS (Switching from Relative to Absolute measurement), mm/inch,
Reference-Lock/Unlock, PRESET (enter a numerical value)
- Life of the battery up to **3 years**
- **MarConnect** data output, choose alternatively: USB, OPTO RS232C or Digimatic
- High contrast Liquid Crystal Display with 12 mm high digits
- Sturdy heavy-duty base, easy to handle
- Hardened and lapped contact surface which produce both a smooth and even movement
- Hand crank for positioning and measuring

Offer price
\$1,700.00
Order no. 4426101

Offer price
\$1,310.00
Order no. 4426100



NEW



814 SR - 0 - 350 mm



814 SR - 0 - 600 mm



For further detailed information see:
www.mahr.com
WebCode 12414-8410

	Measuring range		Resolution	Order no.	Offer Price
	mm	(inch)	mm/inch		
814 SR	350	(14")	0,01 / .0005"	4426100+CAL	\$1,310.00
814 SR	600	(24")	0,01 / .0005"	4426101+CAL	\$1,700.00

Digimar. Height Measuring Instrument Digimar 817 CLM Quick Height - 2D

Digimar 817 CLM Quick Height. 350 / 600 / 1000 mm: The new Height Measuring Instrument with the innovative Quick Mode. Highly accurate rapid measurements, a wide range of measuring and evaluation possibilities and excellent operator comfort.

Fast measurement . . .

... by hand with "Quick-Mode" (patented)



Display

Comfort to operate all measurement functions with the function keys



From **\$7,500.00**



817 CLM - 2D 0 - 350 mm



817 CLM - 2D 0 - 600 mm



817 CLM - 2D 0 - 1000 mm



For further detailed information see:

www.mahr.com

WebCode 12369-8298



- Measuring range
- Application range
- Resolution
- Measuring error*
- Quick Mode
- 2-D
- Motorized measuring carriage
- Bore diameter
- Max-Min
- Tolerance monitoring
- Perpendicularity / Straightness measurement
- Measuring programs
- Temperature compensation
- Air bearings
- Integrated USB memory
- Data interface
- USB printer interface

- mm / in
- mm /in
- mm
- in
- µm
- QUICK MODE
- 2-D
- Motorized measuring carriage
- Bore diameter
- Max-Min
- Tolerance monitoring
- Perpendicularity / Straightness measurement
- Measuring programs
- Temperature compensation
- Integrated USB memory
- Data interface
- USB printer interface

	2D		
	0-350 / 14"	0-600 / 24"	0-1000 / 40"
Application range	520 / 20.47	770 / 30.31	1170 / 46.0
Resolution	0.01 / 0.005 / 0.001 / 0.0005 / 0.0001		
Measuring error*	0.001" / 0.0005" / 0.0001" / 0.00005" / 0.00001"		
Quick Mode	1,8+L/600 (L in mm)		
2-D	●	●	●
Motorized measuring carriage	●	●	●
Bore diameter	●	●	●
Max-Min	●	●	●
Tolerance monitoring	●	●	●
Perpendicularity / Straightness measurement	●	●	●
Measuring programs	40	40	40
Temperature compensation	●	●	●
Air bearings	●	●	●
Integrated USB memory	●	●	●
Data interface	RS232	RS232	RS232
USB printer interface	●	●	●
Order no.	4429010+CAL	4429011+CAL	4429012+CAL
Price	\$7,500.00	\$8,150.00	\$12,700.00

* At 20°C in conjunction with a base plate in accordance to DIN 876/0 and a standard probe K6/51

Digimar. Height Measuring Instrument Digimar 817 CLM Quick Height

Easy to operate . . .

. . . all functions can be operated via the speed keys



Operating and display unit with back-lit display

Measuring program . . .

. . . for repetitive measurements / serial components



Perpendicularity (with optional probes*) . . .

. . . and straightness measurements

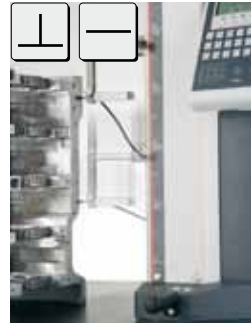

Dynamic measuring functions



Determine MAX, MIN, MAX-MIN with just one measurement

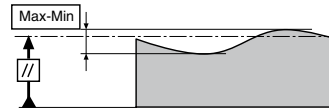

• Parallel deviation

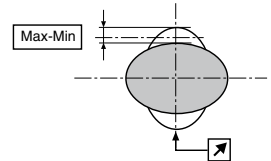

• Roundness deviation

* Check with Mahr Federal Inc. for available electronic probe options

Digimar. Probe Accessory Sets for 817 CLM / 816 CL

Probe Set 817 ts1		Shaft length	Mount
consists of:		mm	dia. mm
817 h2	Carrier for probes	100	—
S15/31,2	Disc probe	31.2	6
Z10/31,2	Cylindrical probe	31.2	6
MKe 30	Taper probe	38.2	6
TMT 120	Depth probe incl. carrier	120	—
KM 2	Probe for M2 incl. probe 800 ts	31.7	6
817 h4	Carrier for probes	—	8
K4/30	Spherical probe	31	8
K6/40	Spherical probe	31	8
K10/60	Spherical probe	62	8
K10/100	Spherical probe	103	8
Carrying case			
Probe Set 817 ts2		Shaft length	Mount
consists of:		mm	dia. mm
817 h2	Carrier for probes	100	—
S15/31,2	Disc probe	31.2	6
Z10/31,2	Cylindrical probe	31.2	6
MKe 30	Taper probe	38.2	6
TMT 120	Depth probe incl. carrier	120	—
KM 2	Probe for M2 incl. probe 800 ts	31.7	6
Carrying case			

From **\$1,040.00**



817 ts1



For further detailed information see:
www.mahr.com
WebCode 12369-8298

Probe Set	Order no.	Price
817 ts1	4429019	\$1,520.00
817 ts2	4429018	\$1,040.00

Pocket Surf® The portable surface roughness gage



- Pocket-sized economically priced, completely portable instrument
- Solidly built, with a durable cast aluminum housing, to provide years of accurate, reliable surface finish gaging
- Can be used to measure any one of four, switch-selectable, parameters: R_a , R_{max}/R_y , R_z
- Selectable traverse length 1, 3 or 5 cut-offs of 0.8 mm/.030"
- Operates in any position – horizontal, vertical, and upside down
- Four switchable probe positions – axial (folded) or at 90°, 180° or 270°
- Even difficult-to-reach surfaces such as inside and outside diameters are accessible
- Integrated data output for SPC-processing
- Easy-to-read LCD readout presents the measured roughness value, in microinches or micrometers

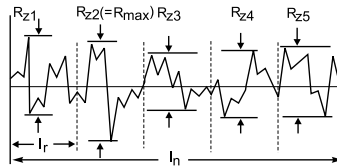

Technical Data

Probing and Traverse Lengths

Parameters	Traverse Length (Nominal)	Evaluation Length	Number of Cutoffs/ Switch Position
R_a/R_y	2.0 mm/ .075" 3.5 mm/ .135"	0.8 mm/ .030" 2.4 mm/ .090"	1 3
$R_a/R_z/R_{max}$	5.0 mm/ .195"	4.0 mm/ .150"	5
Traverse Speed	5.08 mm/ .2" per second		
Cutoff	.08 mm/ .030" ASME 2 RC-filter		
Probe Type	Piezoelectric		
Maximum Stylus Force	15.0 mN / 1500 mgf		
Power	Consumer-type alkaline battery, 9 Volt		
Battery Capacity	Approx. 2500 measurements, depending on frequency of use and output option		
Operating Temperature	10° to 45°C / 50° to 113° F		
Storage Temperature	-20° to 65°C / -4° to 149° F		

Made in USA
Available for fast delivery

Pocket Surf Sets

Order no.			Price
EMD-1500-311+CAL	EGH-1019	Probe, 90°, 10 μ m radius, PMD-90101 Certified Specimen, incl. Test Certificate	\$2,260.00
EMD-1500-312+CAL	EGH-1019	Probe, 90°, 10 μ m radius, EMD-90010 Precision Specimen	\$2,180.00
EMD-1500-321+CAL	EGH-1026	Probe, 90°, 5 μ m radius, PMD-90101 Certified Specimen, incl. Test Certificate	\$2,260.00
EMD-1500-322+CAL	EGH-1026	Probe, 90°, 5 μ m radius, EMD-90010 Precision Specimen	\$2,180.00

A Pocket Surf kit is furnished complete in a fitted case, and includes a Pocket Surf unit with a General Purpose Probe** and a 3.2 μ m/125 μ inch (nominal) Reference Specimen**, 9 Volt battery, Riser Plate and screwdriver.

** Part Numbers listed in table above.

Pocket Surf® PS1 The portable surface roughness measuring instrument



ree
16 ER Caliper

Large display
All the information you need at a glance

Directly selectable parameters
 R_a , R_z

Freely selectable button
Direct access to one parameter of your choice out of 24

USB interface
PS1 is detected without a driver (similar to a flash drive)

Integrated calibration standard
No external calibration standard required (patent pending)

Pick-up with removable pick-up protection
Measurement in compliance with standards
Measuring force 0.7mN

Flexibility thanks to 4 internal threaded bores
for clamping your own special accessories

Drive Unit
Can be rotated and moved in longitudinal direction

Start button on the right and on the left
Easy operation no matter if you are left or right handed

Your Benefits

Saves you time and money

Ease of operation means:

- No training: save time
- Switch on and measure
- 3 parameters directly at the press of a button

Reliable Measurement

- With integrated calibration standard
- Error free operation thanks to **standards compliance settings**
- Automatic cut-off selection
- Evaluation possible using **MarSurf XR 20** evaluation software or **MarSurf XR 20** unit

Pocket Surf® PS1 Standard

The Pocket Surf PS1 comes in a complete set. Thanks to the carrying case, you always have your surface roughness measuring instrument with you as you pass through the production floor. Quick and reliable on-the-spot measurements ensure your quality requirements are met during the production process or incoming goods inspection.

- **Pocket Surf PS1** base unit
- Drive unit
- 1 standard pick-up, conforms to standards
- Integrated battery
- Roughness standard integrated into casing
- Height adjustment accessory
- Pick-up protection
- Charger / mains adapter
- Operating instructions
- Carrying case with shoulder strap and belt attachment
- USB cable
- Mahr Calibration Certificate

Optional accessories

80mm (3.15in) pick-up extension, pick-ups from 3mm (0.118in) dia. measurements in bores, offset pick-up, groove pick-up, gear flank pick-up, adapter for transverse tracing, **MSP2** printer with connection cable (**MarConnect**), vee-block for measurements on end faces, mounting device for measuring stand **ST-D / ST-F / ST-G**. **PC-Software PS1 Explorer** for documentation and records.



Order no.

Price

6910214+CAL

\$2,580.00

36B - I.D./O.D. Gages



- For measuring shafts, bolts, spindles, and other cylindrical parts for thickness and length
- Constant measuring force reduces error
 - Easily adjustable measuring range
 - Direct indication of measuring results
 - Forged steel frame, carbide tipped measuring faces optionally available



Only
\$2,700.00



An I.D./O.D. gaging system with increased versatility

The 36B I.D./O.D. gage is offered with both the "T" plate and "V" plate in the same package. Along with the system will be a 1087B Digital Indicator with latching ability (Min/Max) to save time with both the setup and the measuring process.

When using the 1087B on the 36B gage you simply zero and look for your high and low on the master using the analog scale and re-zero. Place the workpiece on the gage and press the blue start button and

the indicator latches on the high or low depending if you're measuring I.D.'s or O.D.'s, and you're good to go.

- All in one inclusive package
- Faster setup time with the 1087B
- Inch / Metric
- Capability for wireless transmission
- Quicker mastering with Analog / Digital display

Ordering Information

Description	Capacity		Order no.	Price
	ID	OD		
EDI-36B-10 w/"T" Plate and μ Max μ m II	0.75-3.50" (19-89mm)	0.25-5.0" (6-127mm)	EDI-36B-10+CAL	\$2,222.00
EDI-36B-9 w/"V" Plate and μ Max μ m II	0.812-4.625" (21-117mm)	0.312-5.0" (8-127mm)	EDI-36B-9+CAL	\$2,590.00
36B-10 w/Both "T" and "V" Plates and 1087B	Refer to "V" and "T" plate ID/OD dimensions above		2061657+CAL	\$2,700.00

▶ | **DIMENSIONAL METROLOGY**



Precision Gages

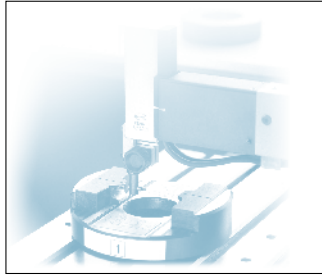

Precimar.
Precision Length Metrology



MarSurf.
Surface Metrology



MarForm.
Form Metrology

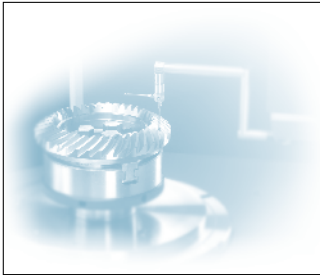

MarGear.
Gear Metrology

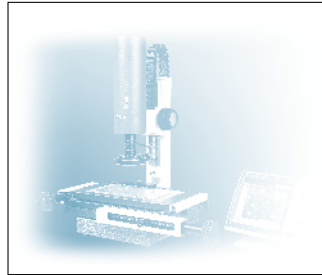

MarVision.
Optical Metrology

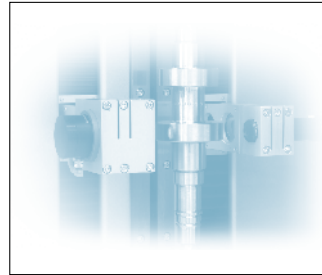

MarShaft.
Shaft Metrology



Services

WWW.MAHR.COM

|
- 0 +



E X A C T L Y